

Command devices

// ES 14 RSSA 27-1m Order no.: 14058009

Features/Options

- Thermoplastic enclosure
- Double insulated
- Mounting hole diameter 22.5 mm
- Mounting details to DIN EN 50 047

- With pre-wired cable, cable length 1 meter
- Actuator: RSSA key switch with safety cylinder lock (locks against turning)
- Normal version always has same key number

Dimensions

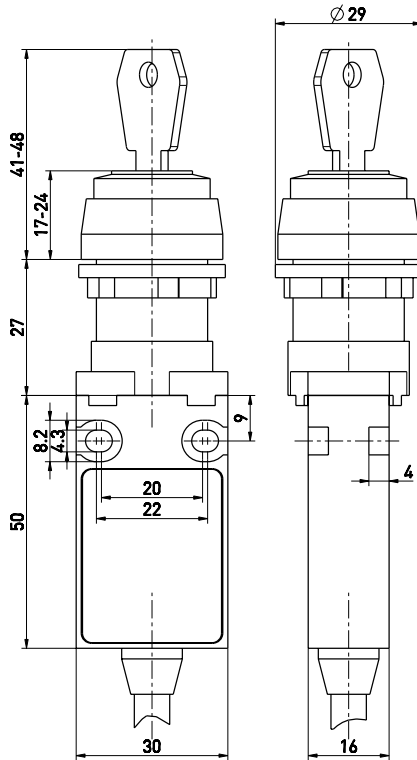

Technical data

Standards	EN ISO 13849-1; IEC/EN 60947-5-1
Enclosure	glass-fibre reinforced, shock-proof thermoplastic, self-extinguishing UL 94-V0
Degree of protection	IP 65 to IEC/EN 60529
Contact material	silver
Switching system	slow action, positive break NC contacts \ominus
Switching elements	change-over contact with double break Zb, galvanically separated contact bridges
Connection	cable H05VV-F
Cable section	4 x 0.75 mm ²
B_{10d} (10% Load)	2 million
T_M	10 years
U_{imp}	4 kV
U_i	250 V
I_{the}	6 A
I_e/U_e	6 A/250 VAC; 0,25 A/230 VDC
Utilisation category	AC-15, DC-13
Max. fuse rating	6 A gL/gG D-fuse
Ambient temperature	-20 °C ... +75 °C
Mechanical life	> 1 million operations
Switching frequency	1800/h
Contact opening	2 x 4 mm

Errors and omissions excepted.

Contact diagram

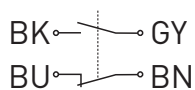

Switching diagram



Switching position RSSA 27



2 switching positions