

Ex command devices

// Ex 14 RSSA 14-1m Order no.: 14058303

Features/Options

- Ex zone 1 and 21
- Double insulation
- Mounting hole diameter 22.5 mm
- With pre-wired cable

- RSSA key switch with safety cylinder lock (locks against turning)
- Normal version always has same key number
- N.B.: Please state required approvals for Russia, China and Brazil with your order!

Dimensions

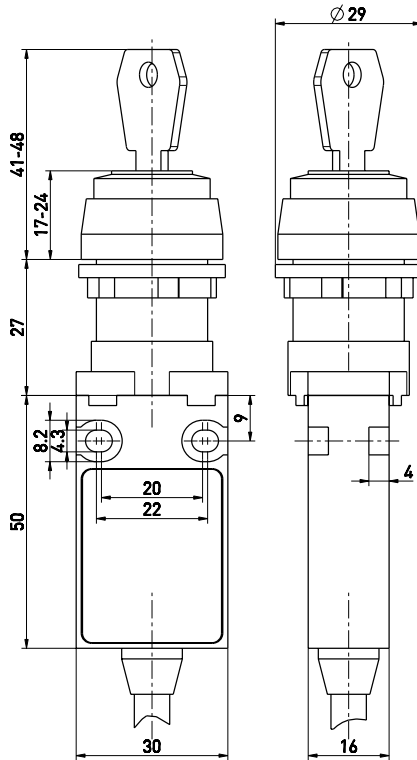

Technical data

Standards	EN 60947-5-1; EN 1088; EN 60079-0; EN 60079-1; EN 60079-31; EN ISO 13849-1
Enclosure	glass-fibre reinforced, shock-proof thermoplastic, self-extinguishing UL 94-V0 IP 65 according to EN 60529
Degree of protection	silver
Contact material	slow action, NC contact with positive break \ominus
Switching system	change-over contact with double break Zb, galvanically separated contact bridges
Switching elements	cable H05VV-F
Connection	4 x 0.75mm ²
Cable section	1m
cable length	60.000
B _{10d} (10% Load)	max. 20 years
T _M	4 kV
U _{imp}	250 V
U _i	T6: 6 A; T5: 3 A
I _{the}	6 A/250 VAC; 0,25 A/230 VDC
I _e /U _e	AC-15, DC-13
Utilisation category	6 A gL/gG D-fuse
Max. fuse rating	T6: -20 °C ... +65 °C; T5: -20 °C ... +95 °C
Ambient temperature	> 30.000 operations
Mechanical life	1800/h
Switching frequency	Switch must be protected from mechanical damage!
Note	
Ex certification	Ex II 2G Ex d IIC T6/T5 Gb, Ex II 2D Ex tb IIIC T80°C/T95°C Db IP65 IECEX Ex d IIC T6/T5 Gb, Ex tb IIIC T80°C/T95°C Db
Approvals	PTB 03 ATEX 1070 X, IECEX PTB 06.0098 X



Errors and omissions excepted.

Ex command devices

// Ex 14 RSSA 14-1m Order no.: 14058303

Contact diagram

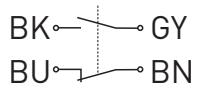

Switching diagram



Switching position RSSA 14



2 switching positions