

Ex emergency pull-wire switches

// Ex ZS 71 10/1S WVD-A / 55 N Order no.: 71042303

Features/Options

- Ex zone 1 and 21
- 2 contacts
- Small design

- Wire length up to 5 m
- Wire pull and breakage function
- N.B.: Please state required approvals for Russia, China and Brazil with your order!

Dimensions

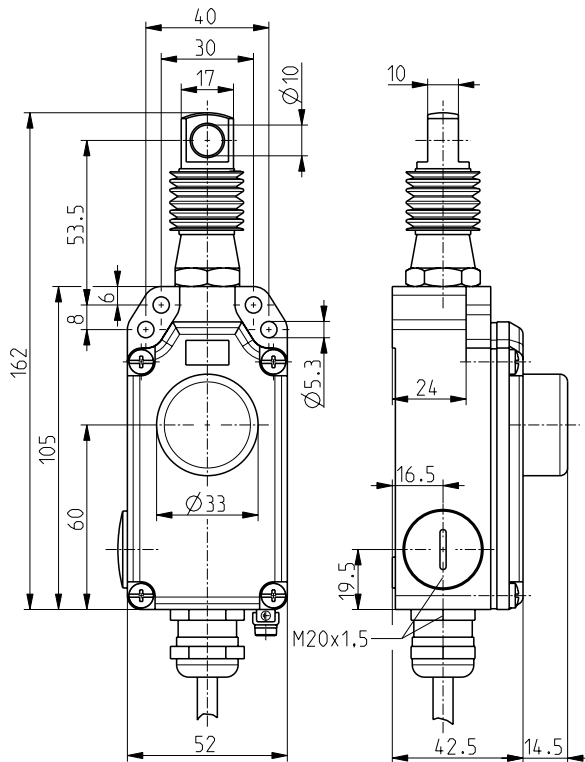

Technical data

Standards	EN 60947-5-1, -5; EN 60079-0, EN 60079-1, EN 60079-31; EN ISO 13849-1
Enclosure	aluminium die-cast, enamel finish
Cover	glass-fibre reinforced, shock-proof thermoplastic, ultramid
Switch insert	Ex 14
Degree of protection	IP 65 to IEC/EN 60529
Contact material	silver
Switching system	slow action, positive break
Switching elements	NC contacts \ominus change-over contact with double break
Connection	cable H05VV-F, length 3m
Cable section	4 x 0.75 mm ² (incl. conductor ferrules)
B_{10d} (10% Load)	200.000
T_M	max. 20 years
U_{imp}	4 kV
U_i	250 V
I_{the}	T6: 6 A, T5: 3 A
Utilisation category	AC-15, DC-13
I_e/U_e	6 A/250 VAC, 0,25 A/230 VDC
Max. fuse rating	6 A gL/gG D-fuse
Ambient temperature	T6: -20 °C ... +65 °C, T5: -20 °C ... +95 °C
Mechanical life	> 1 million operations
Max. wire length	5 m
Features	wire pull and breakage function
Ex certification	Ex II 2G Ex d IIC T6/T5 Gb, Ex II 2D Ex tb IIIC T80°C/T95°C Db IP65 IECEx Ex d IIC T6/T5 Gb, Ex tb IIIC T80°C/T95°C Db
Approvals	PTB 11 ATEX 1003 X, IECEx PTB 07.0034 X



Errors and omissions excepted.