

## Ex emergency pull-wire switches

// Ex ZS 75 20/2S W / 195-275 N Order no.: 75342307

### Features/Options

- Ex zone 1 and 21
- Metal enclosure
- 4 contacts

- Wire length up to 30 m
- Wire pull and breakage detection
- N.B.: Please state required approvals for Russia, China and Brazil with your order!

### Dimensions

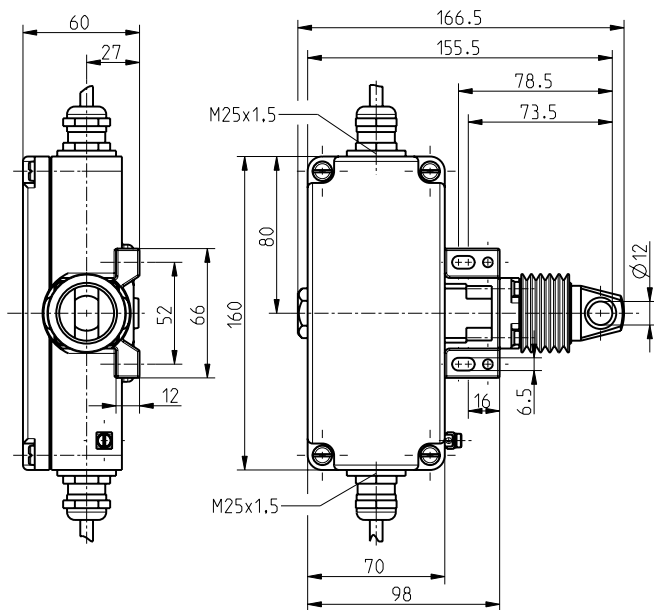

### Switching diagram

#### Slow action

2 NC/2 NO contacts

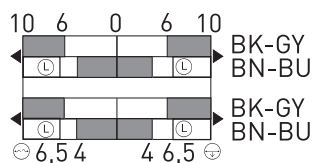

### Technical data

#### Standards

EN 60947-5-1, -5; EN 60079-0, EN 60079-1, EN 60079-31; EN ISO 13849-1

#### Enclosure

aluminium die-cast, enamel finish

#### Cover

aluminium die-cast, enamel finish

#### Switch insert

Ex 14

#### Degree of protection

IP 65 to IEC/EN 60529

#### Contact material

silver

#### Switching system

slow action, positive break NC

contacts ⊖

#### Switching elements

2 NO/2 NC contacts

#### Connection

cable H05VV-F

#### $B_{10d}$ (10% Load)

2 million

#### $T_M$

max. 20 years

#### Cable section

4 x 0.75 mm<sup>2</sup> (incl. conductor ferrules) per switch insert

#### Cable section

3 m

#### $U_{imp}$

4 kV

#### $U_i$

250 V

#### $I_{the}$

T6: 6 A, T5: 3 A

#### Utilisation category

AC-15, DC-13

#### $I_e/U_e$

6 A/250 VAC, 0.25 A/230 VDC

#### Max. fuse rating

6 A gL/gG D-fuse

#### Ambient temperature

T6: -20 °C ... +65 °C;

T5: -20 °C ... +95 °C

#### Mechanical life

> 1 million operations

#### Max. wire length

30 m

#### Features

wire pull and breakage detection

#### Ex certification

⊕ II 2G Ex d IIC T6/T5 Gb,

⊕ II 2D Ex tb IIIC

T80°C/T95°C Db IP65

IECEx Ex d IIC T6/T5 Gb,

Ex tb IIIC T80°C/T95°C Db

#### Approvals

PTB 11 ATEX 1003 X,

IECEx PTB 07.0034 X



Errors and omissions excepted.