

1

STB BEACON STACK

STB2/STB3/STB4
 IP Rating: 4/4X/3R/13, IP66
 Temp: -40°C to +70°C
 CE / UKCA Marked & UL Listed



Mountings
 Multiple mounting lugs with holes
 suitable for up to M6 fixings.

2.5mm² terminals
 Cable entry: M20 cable entry

Complete Unit	Description
STB2DCAA0A1[x]	Junction box with 2 x Beacons - DC
STB2ACAA0A1[x]	Junction box with 2 x Beacons - AC
STB3DCAA0A1[x]	Junction box with 3 x Beacons - DC
STB3ACAA0A1[x]	Junction box with 3 x Beacons - AC
STB4DCAA0A1[x]	Junction box with 4 x Beacons - DC
STB4ACAA0A1[x]	Junction box with 4 x Beacons - AC

Component Unit	Type	Voltage
ST-L101XDC012A1[y]	Xenon	12V DC
ST-L101XDC024A1[y]	Xenon	24V DC
ST-L101XAC115A1[y]	Xenon	115V AC
ST-L101XAC230A1[y]	Xenon	230V AC
ST-L101HDC012A1[y]	LED	12V DC
ST-L101HDC024A1[y]	LED	24V DC
ST-L101HDC048A1[y]	LED	48V DC
ST-L101HAC230A1[y]	LED	115/230V AC

[x] = Housing colour
 R = Red; G = Grey; W = White

[y] = Lens Colour
 A = Amber; B = Blue; C = Clear; G = Green;
 M = Magenta; R = Red; Y = Yellow

- ⚠ ATTENTION : Installation must be carried out by an electrician in compliance with the latest codes and regulations.
- ⚠ ATTENTION : Disconnect from power source before installation or service to prevent electric shock.
- ⚠ ATTENTION : On strobe beacons allow a minimum of 2 minutes for hazardous high voltage to discharge from unit.
- ⚠ ATTENTION : Lens on unit will be hot allow to cool prior to removal.
- ⚠ ATTENTION : Please check factory settings and ensure the correct flash patterns are selected for your country or application.

3

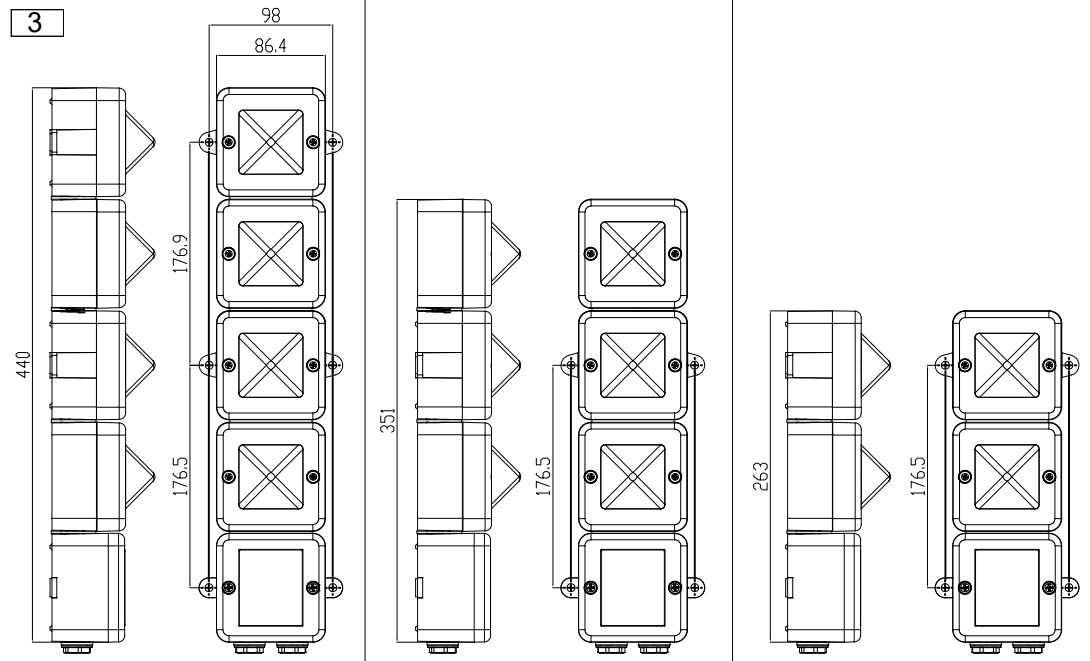

STB4 with 4 Beacons fitted.

STB3 with 3 Beacons fitted.

STB2 with 2 Beacons fitted.



2

Order Code	Nominal Voltage	ST-L101X Xenon Beacon				ST-L101H LED Beacon		
		Voltage Range	Nominal Current	Max Current	Voltage Range	Nominal Current†	Max Current	
STB*DCAA0A1[x]	12 vdc	11.5-14 vdc	500mA	531mA @14 vdc	10-14 vdc	168mA	168mA @14 vdc	
	24 vdc	20-28 vdc	250mA	271mA @20 vdc	16-33 vdc	179mA	183mA @33 vdc	
	48 vdc	42-54 vdc	170mA	160mA @42 vdc	48-260 vdc	115mA	115mA @33 vdc	
STB*ACAA0A1[x]	115 vac	+/-10%	70mA	101mA @126.5 vac	48-260 vac	86mA	166mA @48 vac	
	230 vac	+/-10%	35mA	58mA @253 vac	48-260 vac	53mA	166mA @48 vac	

†Worst case settings (Steady On Mode), refer to ST-L101H unit Instructions for full data
 *Denotes Number of Beacons (2, 3, or 4)
 [x] Denotes Housing Colour: R = Red; G = Grey; W = White

For Voltage Ranges of complete units, take the highest Minimum value and lowest Maximum value in the ranges of the component units
 For Current and Max Current Ratings of complete units, add the ratings from the component units:

Nominal Voltage	ST-L101HDC024A1[y]	ST-L101HDC024A1[y]	ST-L101XDC024[x]	ST-L101XDC024[x]	24V DC
Voltage Range	16- 33 V DC	16- 33 V DC	20 - 28 V DC	20 - 28 V DC	20 - 28 V DC
Current	179mA +	179mA +	250mA +	250mA	858mA
Max Current	183mA +	183mA +	271mA +	271mA +	908mA

i.e. STB4DCAA0A1[x]

4

Alarm Cabling

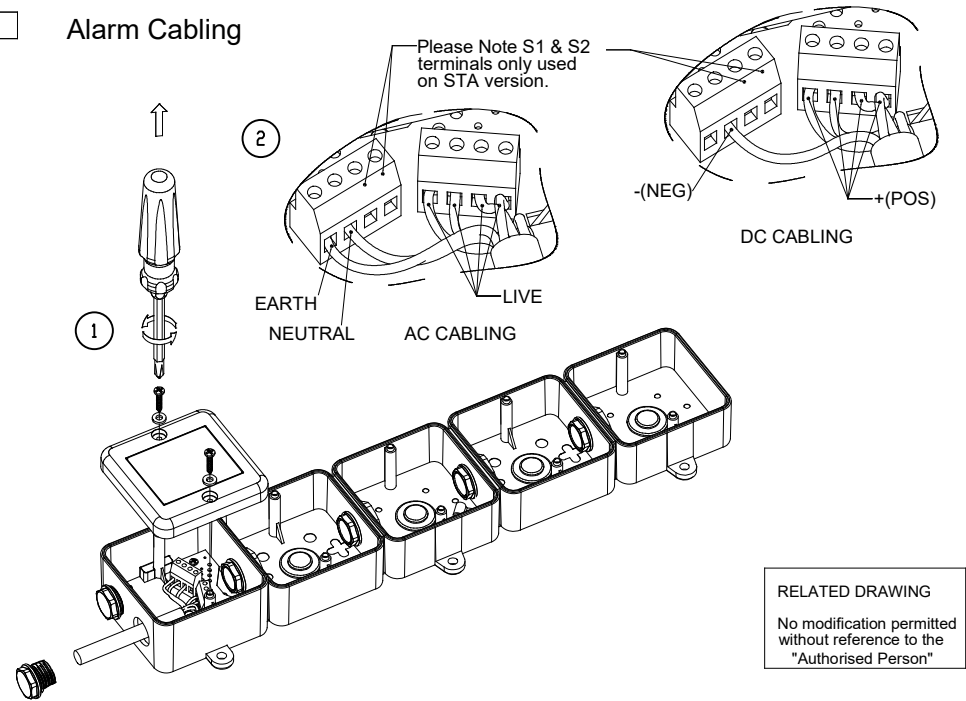

RELATED DRAWING
 No modification permitted without reference to the "Authorised Person"

5

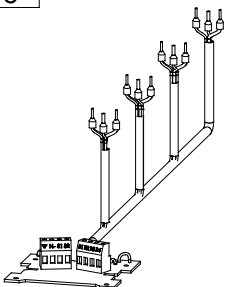

STB AC CABLE LOOM PRE-INSTALLED.

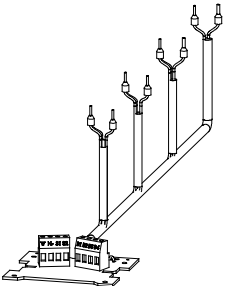
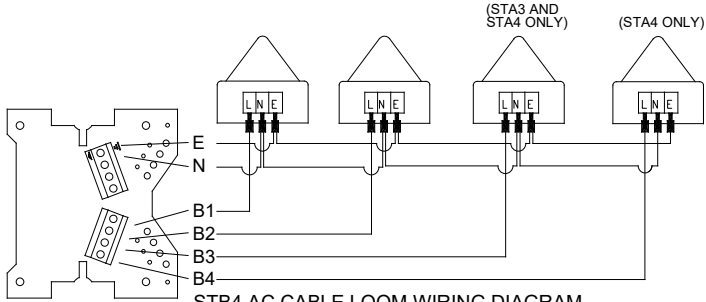

STB DC CABLE LOOM PRE-INSTALLED.

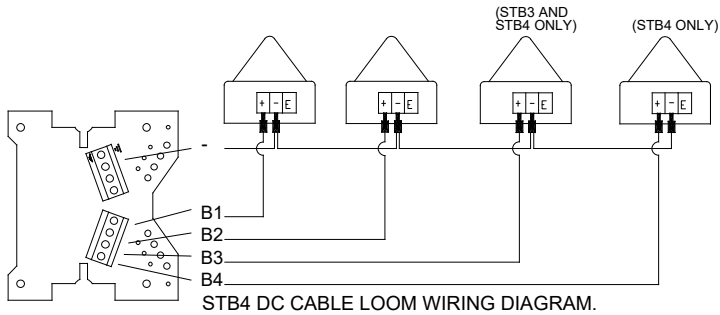

7



ST-L101H LED Beacon

Refer to D171-10-900-IS for full details of ST-L101H LED Beacon

Reference for Voltage Link Settings (DC only)

Jumper Setting	Jumper Link 4	Jumper Link 5	Jumper Link 6
24VDC Mode (Default)	Open	Closed	Open
12VDC Mode (Customer set)	Closed	Open	Closed

12V DC & 24V DC Terminals

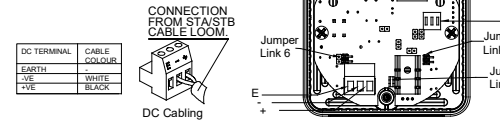

AC/DC Units: 48V DC; 115V AC & 230V AC Terminals

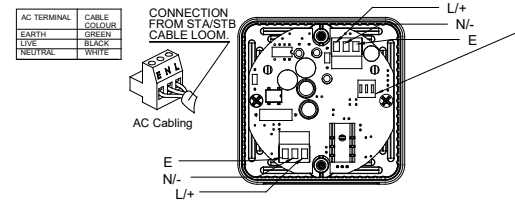

Flash Pattern Settings (AC & DC Units)

Switch Setting	Flash Mode
(0 0 0)	Steady On
(1 0 0)	Blinking
(0 1 0)	Flashing 1Hz
(1 1 0)	Flashing 1.5Hz
(0 0 1)	Flashing Double Strike
(1 0 1)	Flashing Triple Strike
(0 1 1)	Flashing 2Hz
(1 1 1)	Flashing - Temporal

Flash Mode Dip Switch Shown with 1-OFF, 2-ON, 3-OFF (0 1 0). This denotes flash mode 1Hz. For further flash modes, see table adjacent



6

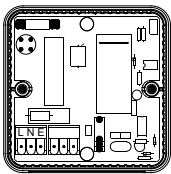

ST-L101X Xenon Beacon

Refer to D171-10-800-IS for full details of ST-L101X Xenon Beacon

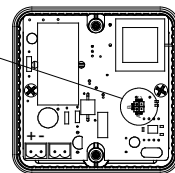
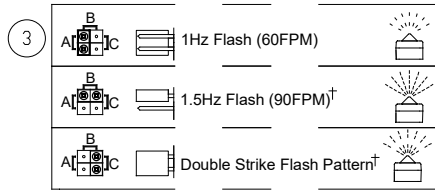
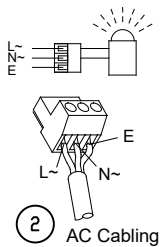

8

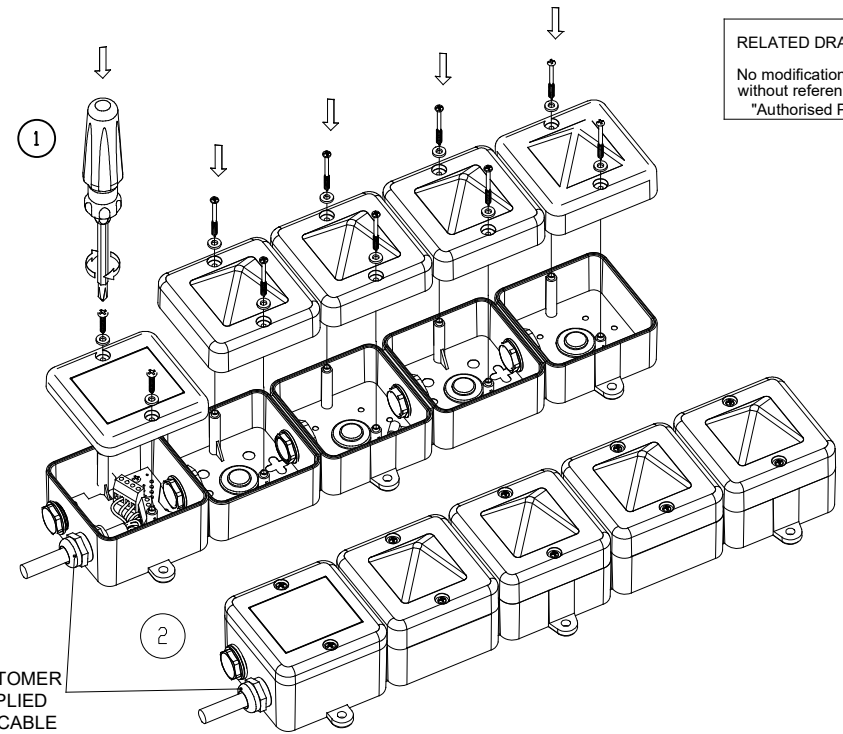

RELATED DRAWING

No modification permitted without reference to the "Authorised Person"