

# INSTRUCTION & SERVICE MANUAL

## L101H Range - L.E.D Beacon

18 x High Powered L.E.Ds  
 8 Flash Modes:  
 Flashing - 1 Hz, 1.5Hz, 2Hz, Double Strike, Triple Strike,  
 Temporal, Blinking, Steady On  
 IP Rating: Type 4 / 4X / 3R / 13, IP66  
 Temp: -40°C to +70°C  
 Unit weight: 200g  
 CE & UL Listed  
 General Signalling for US & Canada - UL1638A & CSA22.2-205-17  
 Private Mode Fire for US & Canada - UL1638, CAN/ULC-S526

Dimensions : 86.0 x 86.0mm  
 0.2 - 2.5mm<sup>2</sup> terminals /  
 AWG24-AWG14  
 Cable entry: M20 cable entry  
 Dependent on Back Box selected

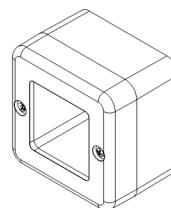

L101H

Backbox Type See D185-05-001

Standard L101  
 Backbox

[B]

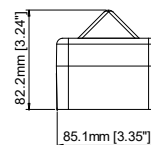
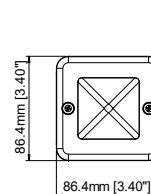

Multi-purpose  
 Backbox

[M]

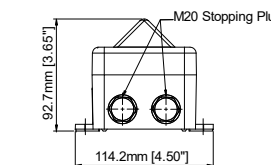
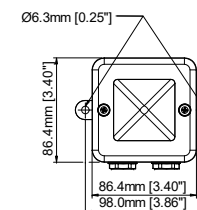

Sonora  
 Backbox

[S]

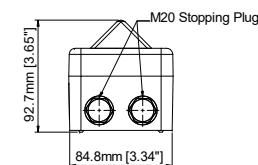
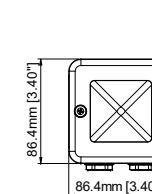

Model No.	Nominal Voltage	Voltage Range	Nominal Current†	Max Operating RMS#
L101HDC024[Z]...[X]/[Y]	12V dc*	10-14V dc/ac	79.5mA	168mA
	24V dc	16-33V dc/ac	87mA	183mA
L101HAC230[Z]...[X]/[Y]	48V dc	48-260Vdc	60mA	115mA
	115V ac	48-260V ac	34mA	166mA
	230V ac	50/60HZ	19mA	166mA

[Z] Denotes Backbox Type: B = Standard L101; S = Sonora; M = Multi-purpose (with Lugs)  
 [X] Denotes Housing Colour: R = Red; G = Grey; W = White  
 [Y] Denotes Lens Colour: R = Red; G = Green; A = Amber; B = Blue; C = Clear; M = Magenta  
 \*Customer to set 12V dc mode using Jumpers on board - See DC Voltage Link Settings  
 † Nominal current at nominal voltage and 1Hz Flash Pattern  
 # Max Operating Current for worst-case input voltage and worst-case flash pattern

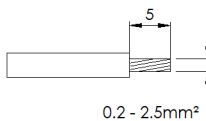

Use suitable conduit or cable glands with suitable IP or type rating

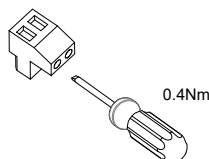

Terminal Connections

Access to Enclosure

**ATTENTION:** Do not paint / Ne pas peindre

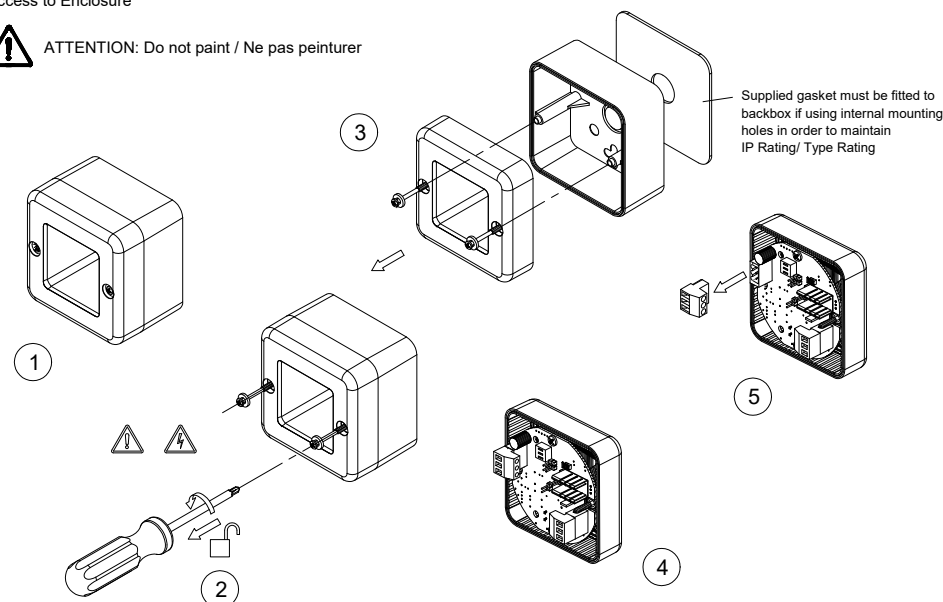

Attention: Installation must be carried out by an electrician in compliance with the latest codes and regulations.  
 Attention: L'installation doit être effectuée par un électricien conformément aux derniers codes et réglementations.  
 Achtung: Die Installation muss von einem Elektriker gemäß den neuesten Vorschriften und Bestimmungen durchgeführt werden.

Attenzione: L'installazione deve essere eseguita da un elettricista in conformità con i codici e le normative più recenti.

Atención: La instalación debe ser realizada por un electricista de acuerdo con los últimos códigos y regulaciones.

Atenção: A instalação deve ser realizada por um electricista de acordo com os códigos e regulamentos mais recentes.

Внимание: установка должна выполняться электриком в соответствии с последними нормами и правилами.

Attention: Disconnect from power source before installation or service to prevent electric shock

Attention: Débranchez-le de la source d'alimentation avant l'installation ou l'entretien pour éviter tout choc électrique.

Achtung: Vor Installation oder Wartung von der Stromquelle trennen, um einen Stromschlag zu vermeiden.

Attenzione: scollegare dall'alimentazione prima dell'installazione o dell'assistenza per evitare scosse elettriche.

Atención: desconéctelo de la fuente de alimentación antes de la instalación o el servicio para evitar descargas eléctricas.

Atenção: Desconecte da fonte de alimentação antes da instalação ou serviço para evitar choque elétrico

Внимание: отключите от источника питания перед установкой или обслуживанием, чтобы предотвратить поражение электрическим током.



DC PCBA  
DC Voltage Link Settings

**L101HDC024**  
**(24VDC Mode - Default Setting)**

Voltage Range: 16-33Vdc (Regulated)  
Nominal Voltage: 24Vdc

Jumper Setting	Jumper Link 4	Jumper Link 5	Jumper Link 6
24VDC Mode (Default)	Open	Closed	Open
12VDC Mode (Customer Set)	Closed	Open	Closed

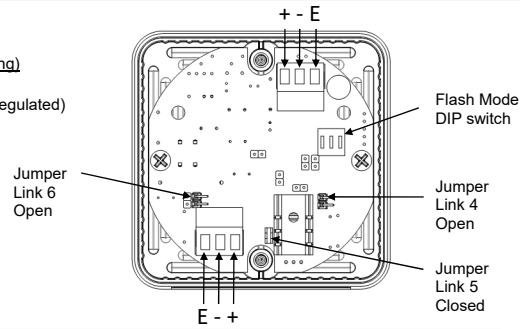

**L101HDC024**  
**(12VDC Mode - Customer to Set)**

Voltage Range: 10-14Vdc  
Nominal Voltage: 24Vdc

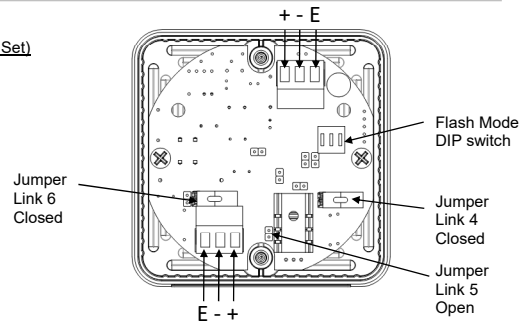

See D228-06-001 for schematic

Re-assembly

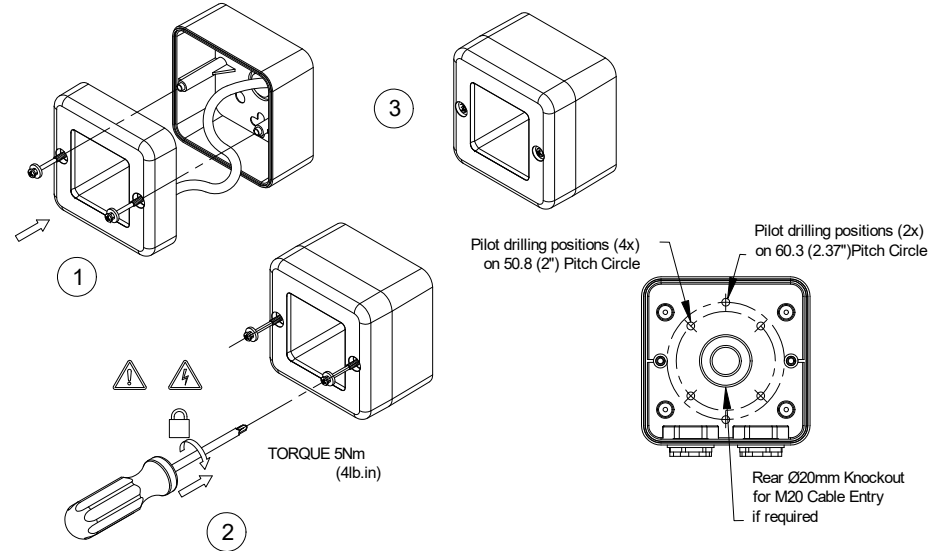

AC PCBA

**L101HAC230**

Voltage Range: 48-260Vac / 48-260Vdc  
Nominal Voltage: 115Vac 50/60Hz  
Nominal Voltage: 230Vac 50/60Hz  
Nominal Voltage: 48Vdc

Flash Mode Settings

The Flash Mode Dip Switch can be changed to set the desired flash pattern.

Switch Setting	Flash Mode
0 0 0	Steady on
1 0 0	Blinking
0 1 0	Flashing 1Hz*
1 1 0	Flashing 1.5Hz*
0 0 1	Flashing - Double Strike
1 0 1	Flashing - Triple Strike
0 1 1	Flashing 2Hz*
1 1 1	Flashing - Temporal

\*Setting permitted for use as private mode fire alarm device

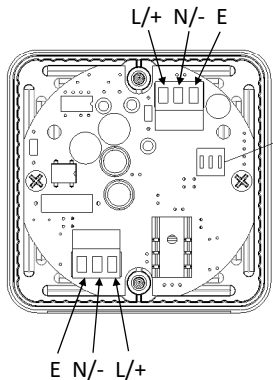

Flash Mode DIP Switch Shown with 1-OFF, 2-ON, 3-OFF (0 1 0). This denotes Flash mode 1Hz. For further flash modes refer to table.

**Private Mode Fire Alarm Ratings**

All models are approved for use as Visual Appliance for use as General Signaling.  
All models are approved for use as Visual Appliance for use in Fire Alarm Systems – Private Mode.  
For private mode fire alarm use the beacons must only be fitted with clear plastic lens covers and must be set to one of the certified flash patterns of 1Hz, 1.5Hz or 2Hz.

Surge current ratings for use in fire alarm systems					
Model	Nominal Voltage	Voltage Range	Flash Rate	Initial Peak (mA)	Initial RMS (mA)
L101HDC024	12Vdc	10 to 14Vdc	1 Hz	202	172
			1.5Hz	216	172
			2Hz	224	172
	24Vdc	16 to 33Vdc (Regulated)	1 Hz	950	204.3
			1.5Hz	968.5	206.7
			2Hz	969	205.2
L101HAC230	115/230Vac 50Hz	48 to 260Vac	1 Hz	400	163
			1.5Hz	400	158
			2Hz	696	126
	115/230Vac 60Hz	48 to 260Vac	1 Hz	831.4	150.6
			1.5Hz	984.7	152.9
			2Hz	925.6	162.4

On-axis light output rating per UL1638:

Model	Intensity (cd) at 1Hz flash rate	Intensity (cd) at 1.5Hz flash rate	Intensity (cd) at 2Hz flash rate
L101HDC024 (12Vdc Mode)	5.9	5.97	6.35
L101HDC024 (24Vdc Mode)	11.65	12.32	12.38
L101HAC230 (115Vac)	12.99	12.65	14.1
L101HAC230 (230Vac)	13.12	13.22	13.45